

# LADYBIRD CRANE HIRE

## IGO 21

SUPPLIERS OF PEDESTRIAN OPERATED SELF-ERECTING TOWER & CITY CRANES

## Crane Specifications

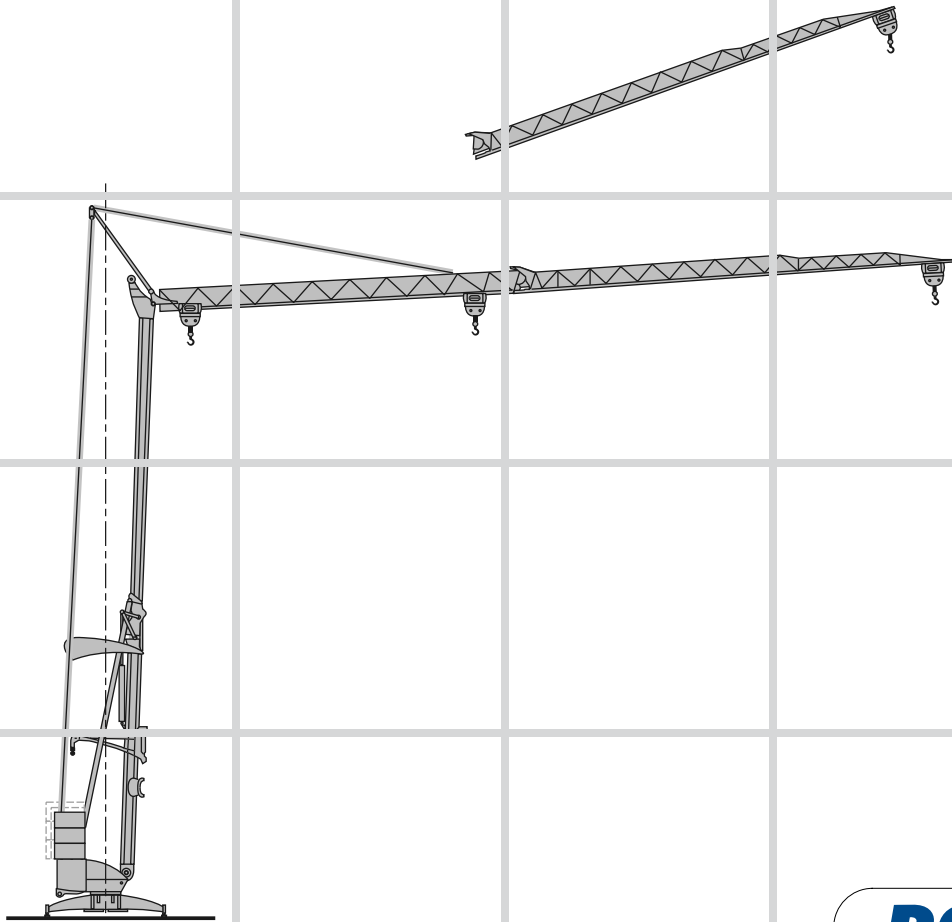

**POTAIN** 

## LADYBIRD CRANE HIRE

LADYBIRD BARN,  
OLD BURCOT LANE,  
BROMSGROVE,  
WORCESTERSHIRE  
B60 1PH

t: 01527 889 889

f: 01527 889 879

e: [info@ladybirdcranehire.co.uk](mailto:info@ladybirdcranehire.co.uk)

w: [www.ladybirdcranehire.co.uk](http://www.ladybirdcranehire.co.uk)

# IGO 21

## 26m Self-Erecting Crane

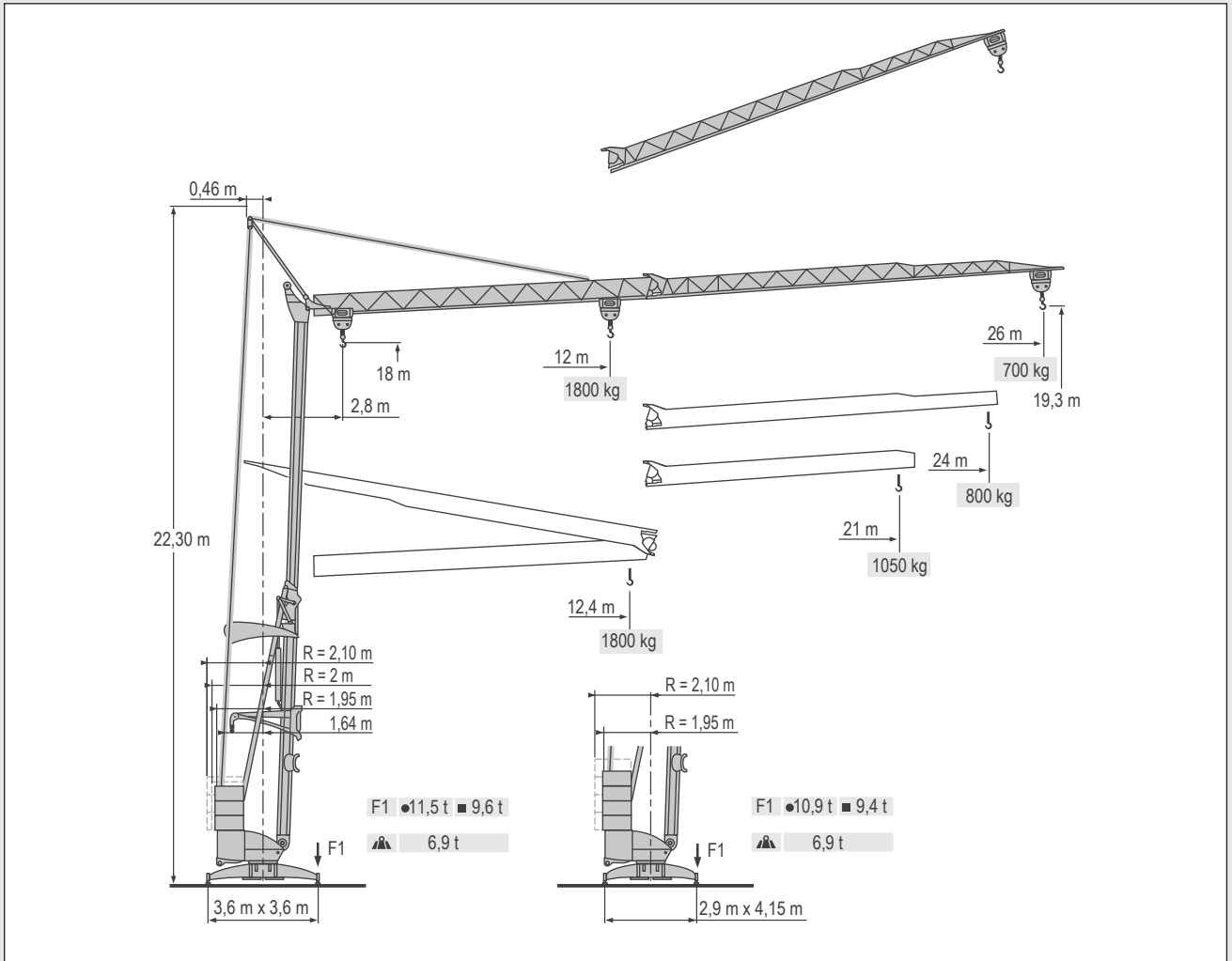

**Load Diagrams**

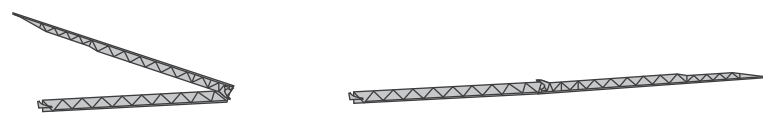

















Jib Length (m)	Counter-jib Length (m)	Load Capacity (kg)	12	13	14	15	16	17	18	19	20	21	22	23	24	25	26
26 m	2.8	1800	1800	1630	1490	1370	1265	1175	1095	1025	965	910	860	815	775	735	700
24 m	2.8	1800	1800	1685	1535	1415	1310	1215	1135	1060	1000	940	890	845	800		
21 m	2.8	1800	1800	1710	1570	1455	1350	1265	1185	1115	1050						

Specifications and data not binding. Subject to modification without notice



## Mechanisms

-  Hoisting
-  Trolleying
-  Slewing
-  50 Hz Single phase

										ch - PS	kW
				↑ 3,5 ↓ 3,5	↑ 7 ↓ 16	↑ 18 ↓ 36			hp		
	8 LVF 9 Optima	230 V 20 A  1	m/min	1800	1800	700			3,3	2,4	
		230 V 32 A  2	m/min	1800	1800	700			5,2	3,8	
		400 V  3	m/min	1800	1800	700			7,5	5,5	
	1 DVF 4-1	-	m/min	14 → 36 (0 → 700 kg) - 14 → 28 (700 → 1800 kg)					1,5	1,1	
	RVF 20	-	tr/min U/min rpm	0 → 1					1,5	1,1	
CEI 38 		IEC 38		<b>kVA</b>							
230 V (+6% -10%) 50 Hz 		400 V (+6% -10%) 50 Hz		230 V 20 A : 4,6 kVA 230 V 32 A : 7,4 kVA		2000/14					
				400 V : 11 kVA							

## Erection

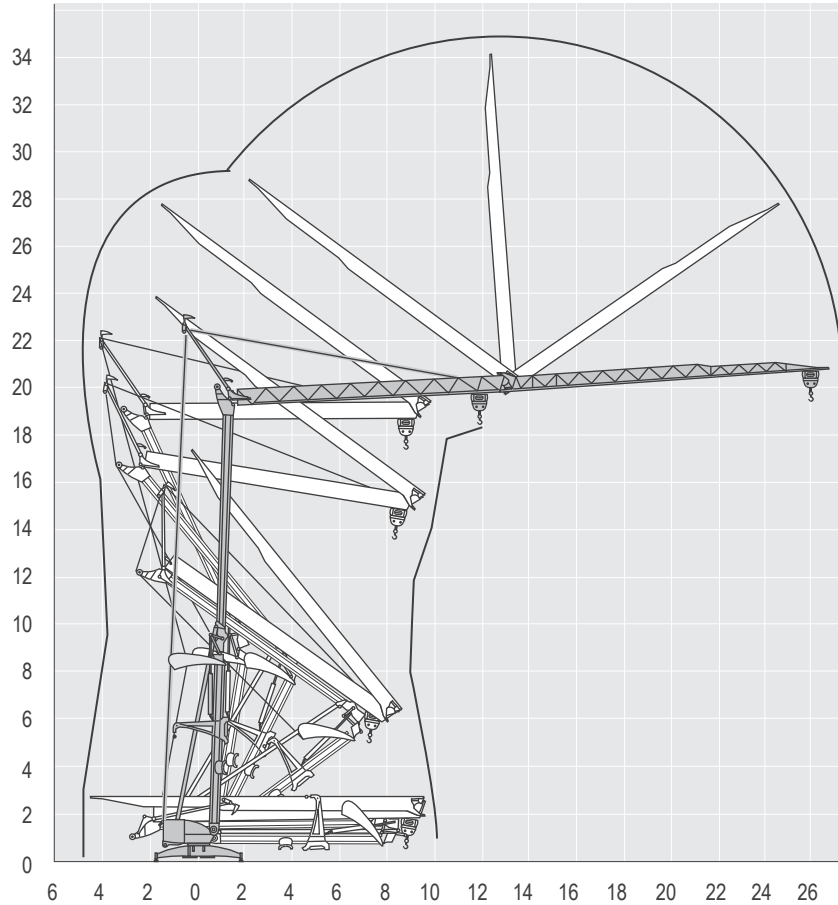

Specifications and data not binding. Subject to modification without notice