

# LADYBIRD CRANE HIRE

# IGO 32

SUPPLIERS OF PEDESTRIAN OPERATED SELF-ERECTING TOWER & CITY CRANES

## Crane Specifications

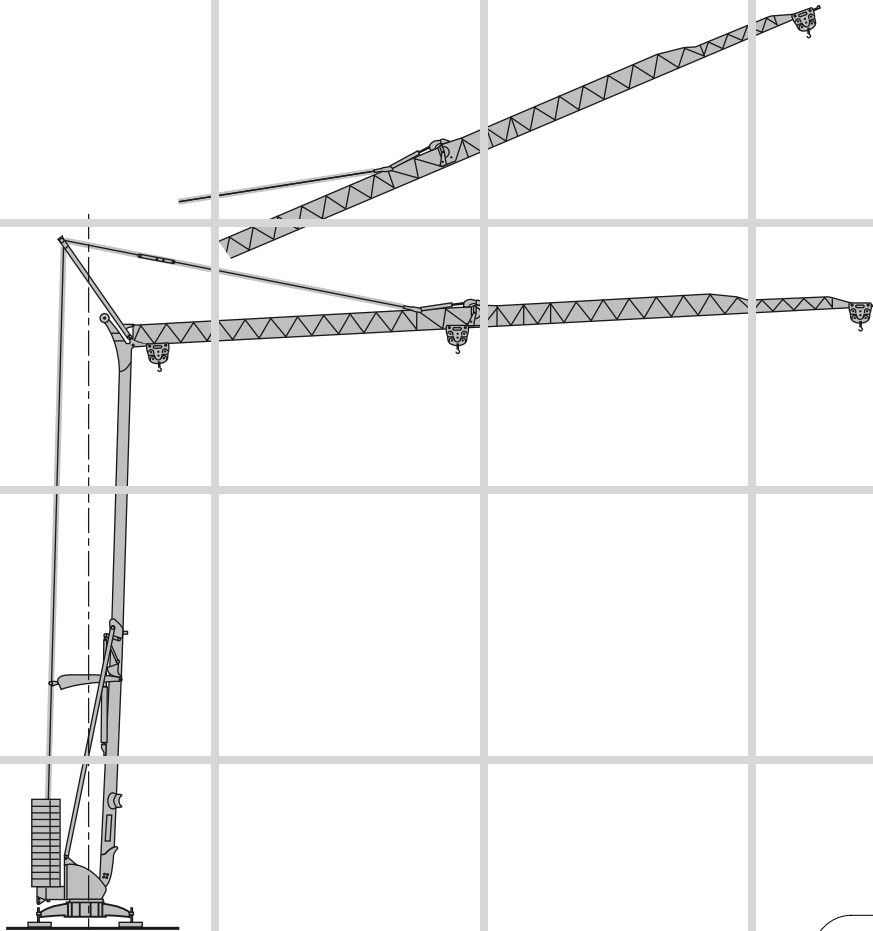

**POTAIN** 

## LADYBIRD CRANE HIRE

LADYBIRD BARN,  
OLD BURCOT LANE,  
BROMSGROVE,  
WORCESTERSHIRE  
B60 1PH

t: 01527 889 889

f: 01527 889 879

e: [info@ladybirdcranehire.co.uk](mailto:info@ladybirdcranehire.co.uk)

w: [www.ladybirdcranehire.co.uk](http://www.ladybirdcranehire.co.uk)

## 30m Self-Erecting Crane

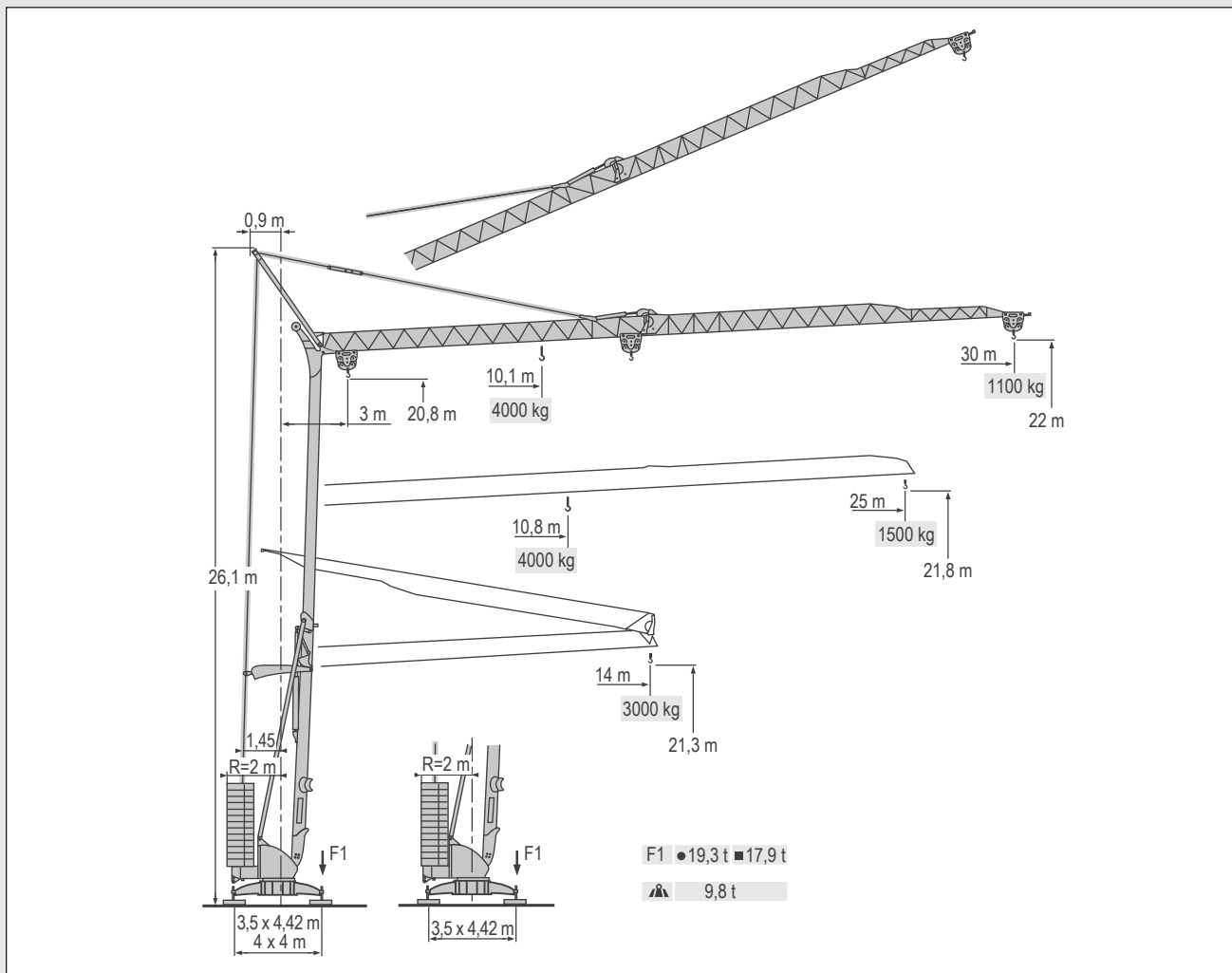

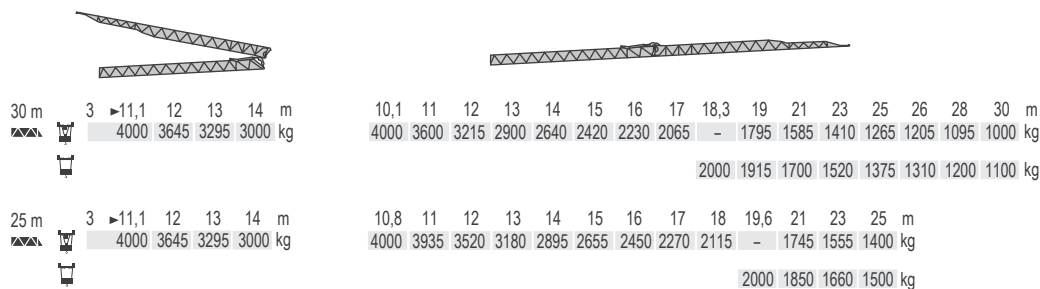

### Load Diagrams









Specifications and data not binding. Subject to modification without notice



### Mechanisms

-  Hoisting
-  Trolleying
-  Slewing

													ch - PS hp	kW
	15 LVF 10 Optima	m/min	3,6	18	30	49	66						15	11
		kg	2000	2000	2000	1100	500							
		m/min	3,6	18	30	54	66	1,8	8,9	15	27	33		
		kg	2000	2000	2000	1000	500	4000	4000	4000	2000	1000		
	3 DVF5	m/min	19 - 41									3	2,2	
	RVF2-30	tr/min U/min rpm	0 → 0,8									2	1,5	
CEI 38			IEC 38		<b>kVA</b>									
400 V (+6% -10%) 50 Hz			15 LVF 10 : 20 kVA					2000/14						

### Erection

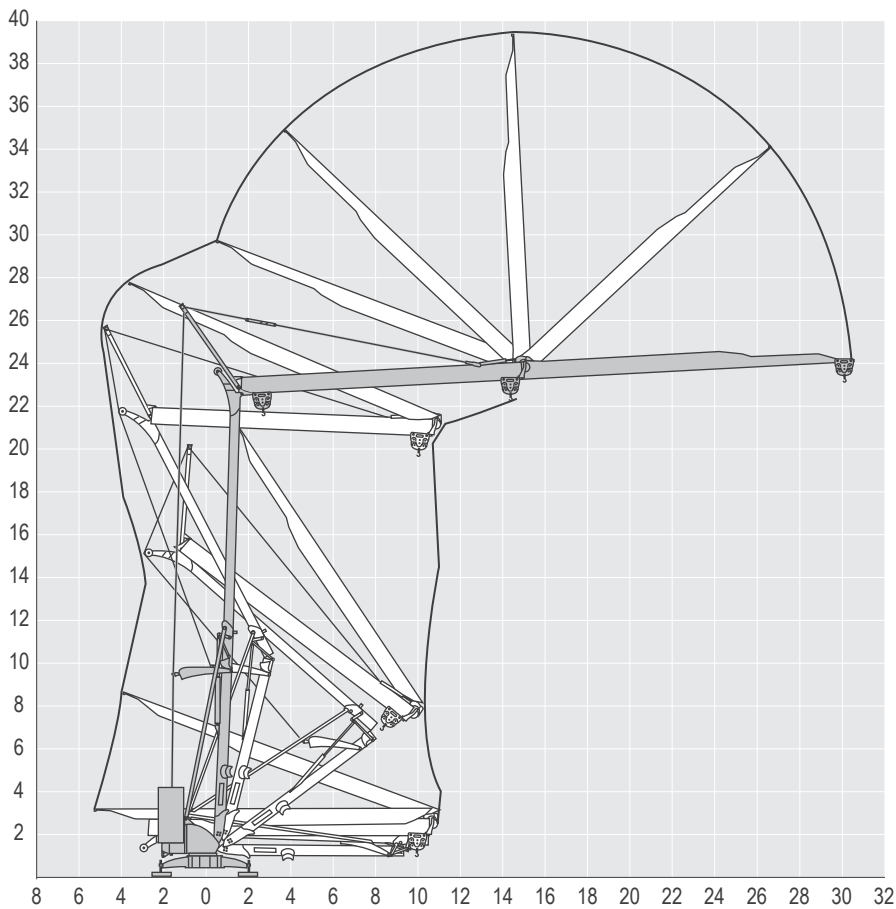

Specifications and data not binding. Subject to modification without notice