

# LADYBIRD CRANE HIRE

## IGO 36

SUPPLIERS OF PEDESTRIAN OPERATED SELF-ERECTING TOWER & CITY CRANES

## Crane Specifications

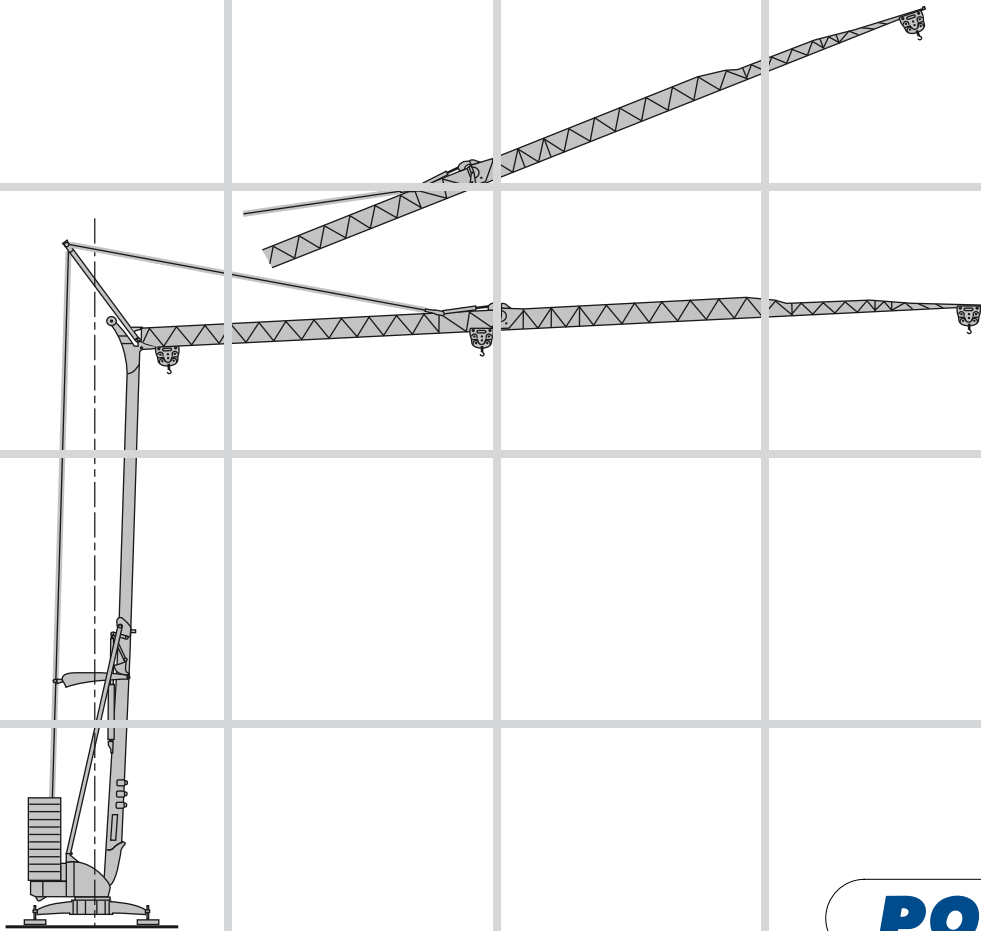

**POTAIN** 

## LADYBIRD CRANE HIRE

LADYBIRD BARN,  
OLD BURCOT LANE,  
BROMSGROVE,  
WORCESTERSHIRE  
B60 1PH

t: 01527 889 889

f: 01527 889 879

e: [info@ladybirdcranehire.co.uk](mailto:info@ladybirdcranehire.co.uk)

w: [www.ladybirdcranehire.co.uk](http://www.ladybirdcranehire.co.uk)



## 32m Self-Erecting Crane

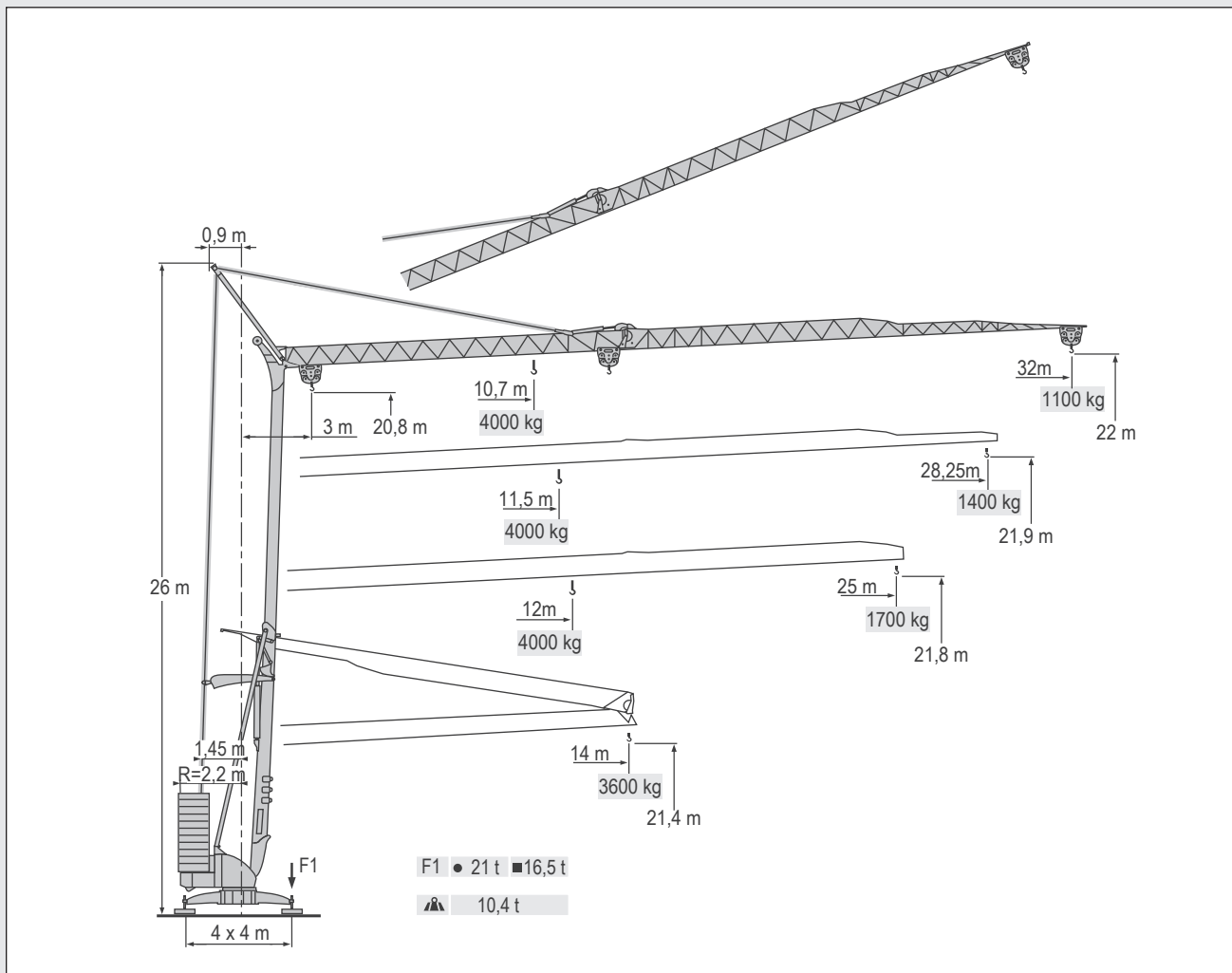



### Load Diagrams







Configuration	Height (m)	Load Capacity (kg)	Distance (m)
32 m	3	4000	12,87
		3950	13
		3600	14
		4000	10,7
		3870	11
		3460	12
		3125	13
		2845	14
		2610	15
		2410	16
		2230	17
28,25 m	3	4000	11,5
		3950	12
		3600	13
		4000	11,5
		3790	12
		3420	13
		3120	14
		2860	15
		2640	16
		2450	17
		2280	18
25 m	3	4000	12
		3950	13
		3600	14
		4000	12
		3600	13
		3280	14
		3010	15
		2775	16
		2580	17
		2400	18
		2250	19

Specifications and data not binding. Subject to modification without notice



### Mechanisms

-  Hoisting
-  Trolleying
-  Slewing

												ch - PS hp	kW	
	15 LVF 10 Optima	m/min	3,6	18	30	49	66						15	11
		kg	2000	2000	2000	1100	500							
		m/min	3,6	18	30	54	66	1,8	8,9	15	27	33		
		kg	2000	2000	2000	1000	500	4000	4000	4000	2000	1000		
	3 DVF5	m/min	19 - 41									3	2,2	
	RVF2-50	tr/min U/min rpm	0 → 0,8									4	3	
CEI 38 		IEC 38	kVA											
400 V (+6% -10%) 50 Hz			15 LVF 10 : 22 kVA			2000/14								

### Erection

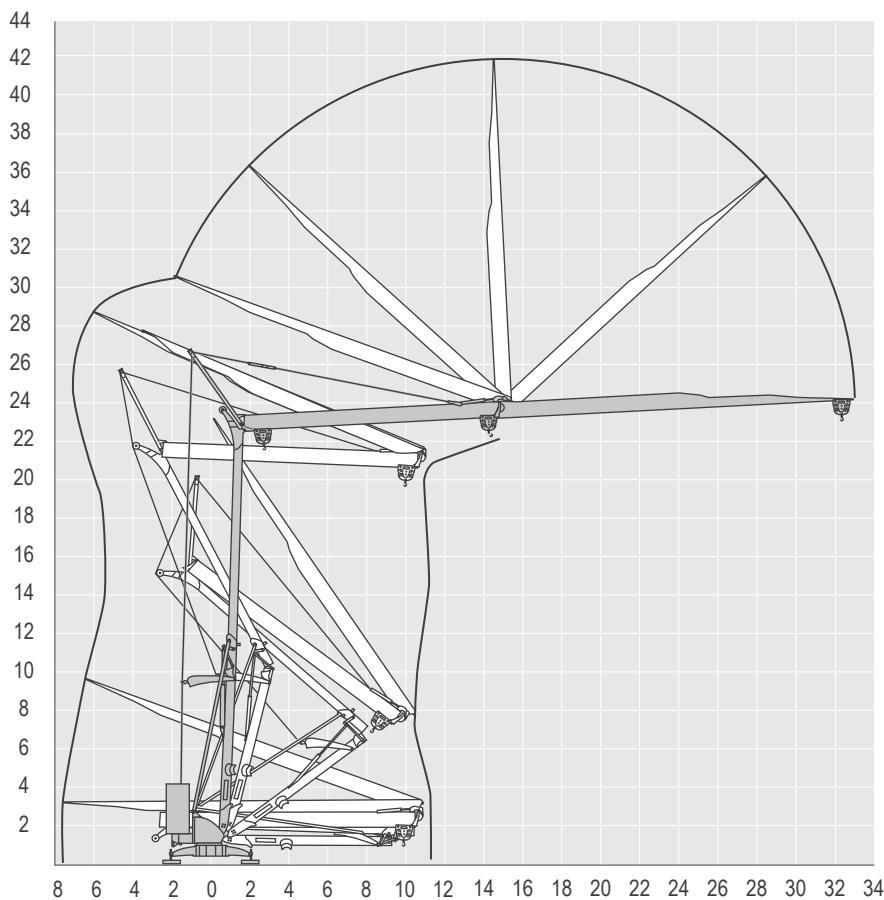

Specifications and data not binding. Subject to modification without notice