



# LADYBIRD CRANE HIRE

# IGO 50

SUPPLIERS OF PEDESTRIAN OPERATED SELF-ERECTING TOWER & CITY CRANES

## Crane Specifications

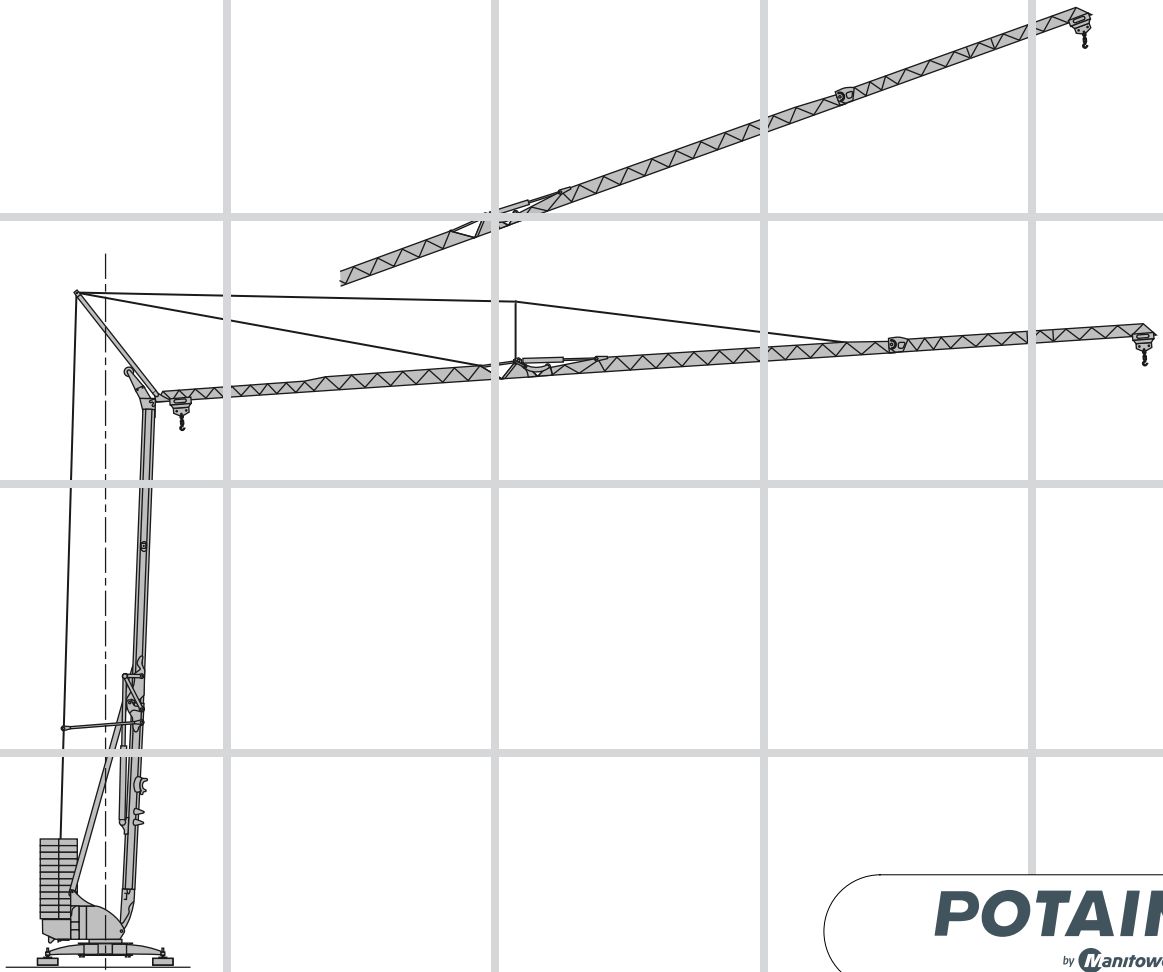

**POTAIN**  
by **L**anitowoc

## LADYBIRD CRANE HIRE

LADYBIRD HOUSE  
BROCKHILL YARD  
HEWELL LANE  
REDDITCH  
B97 6QT

t: 01527 889 889

f: 01527 889 879

e: [info@ladybirdcranehire.co.uk](mailto:info@ladybirdcranehire.co.uk)

w: [www.ladybirdcranehire.co.uk](http://www.ladybirdcranehire.co.uk)





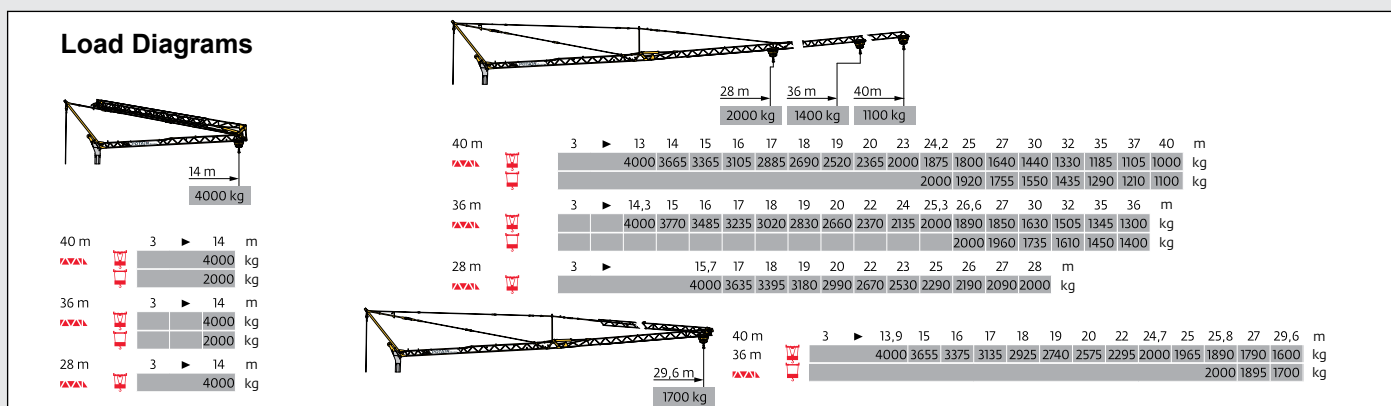
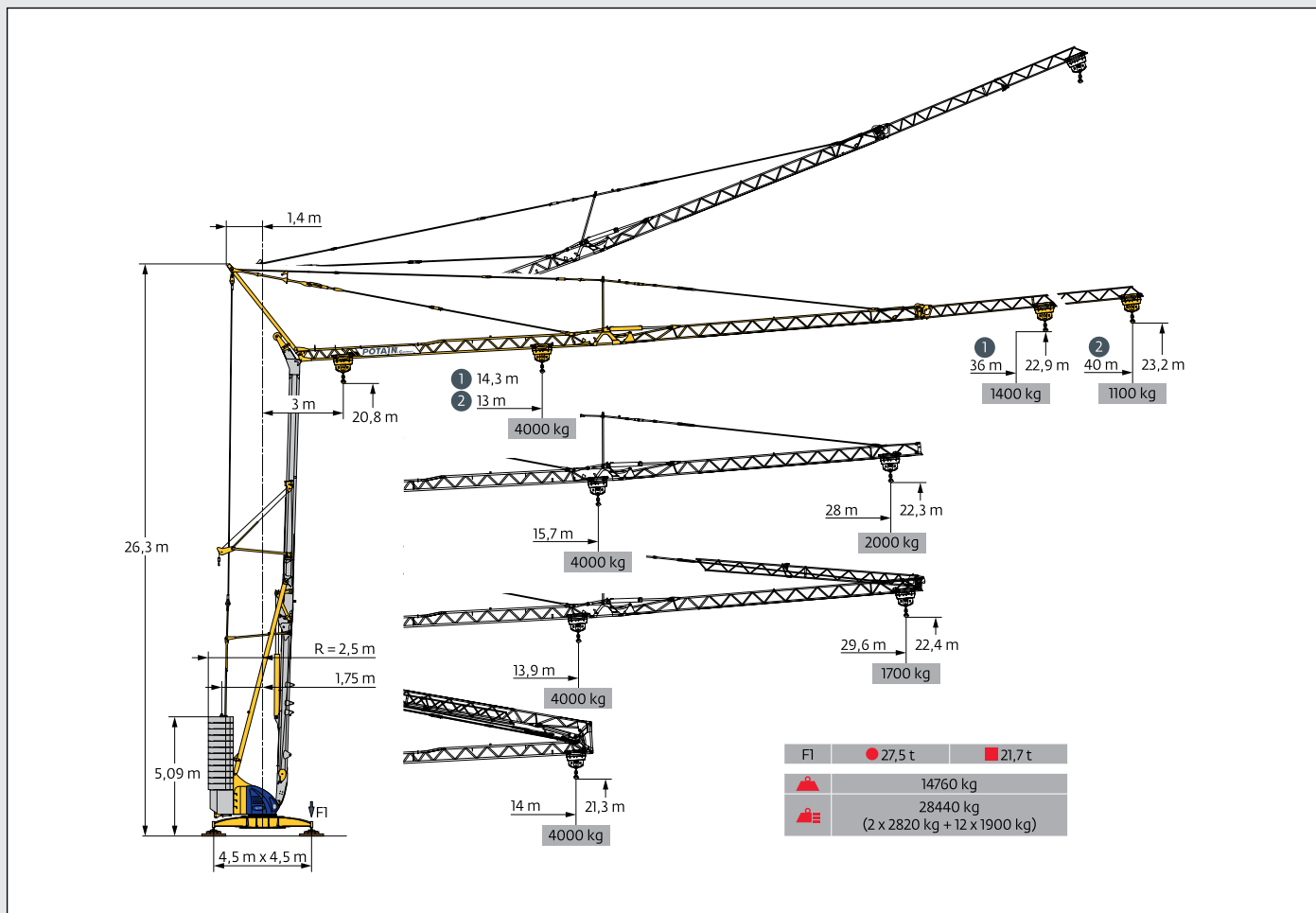





## 40m Self-Erecting Crane





Specifications and data not binding. Subject to modification without notice



## Mechanisms

												ch - PS hp	kW			
	15 LVF 10 Optima	m/min	3,6	18	30	49	66						15	11		
		kg	2000	2000	2000	1100	500									
	3 DVF5	m/min	3,6	18	30	54	66	1,8	8,9	15	27	33	3	2,2		
		kg	2000	2000	2000	1000	500	4000	4000	4000	2000	1000				
	RVF+ 51	m/min	19 - 41										5,5	4		
		tr/min U/min rpm	0 → 0,8													
		CEI 38 	IEC 38													
		400 V (+6% -10%) 50 Hz					15 LVF 10 : 22 kVA					2000/14				

-  Hoisting
-  Trolleying
-  Slewing

## Erection

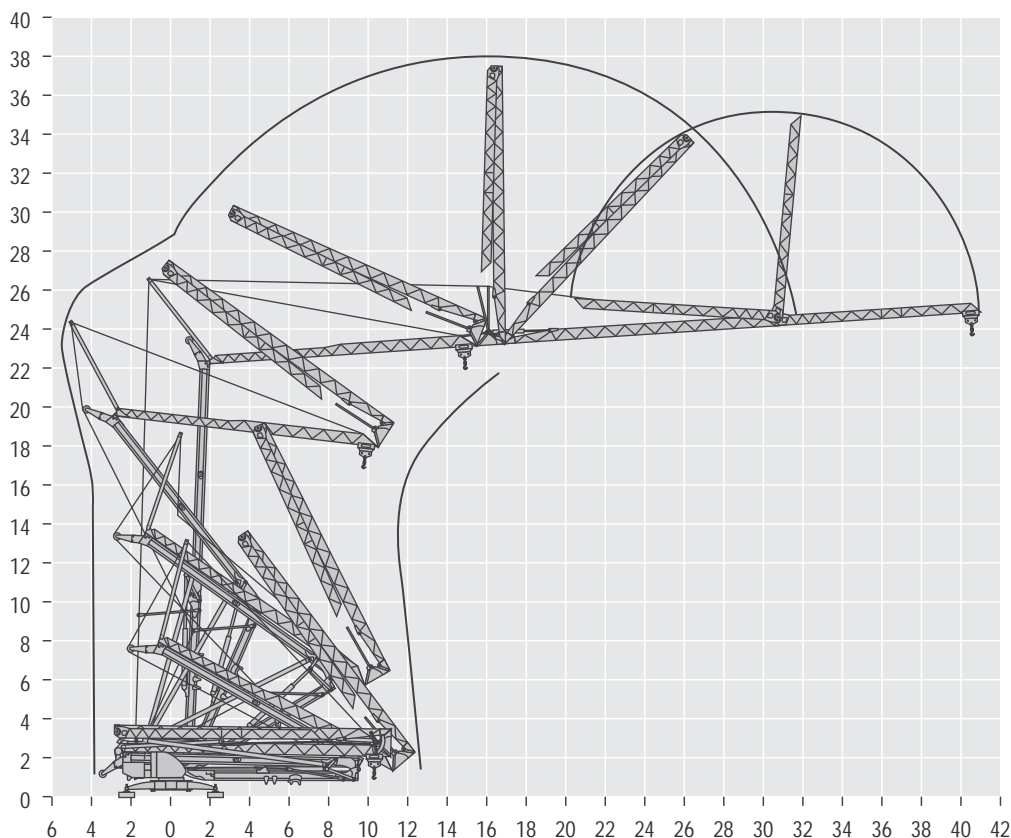

Specifications and data not binding. Subject to modification without notice